



If you're ready to draw the line at average and reach for better call us today.

To locate Steel-Line branches across Australia call: **1300 427 243** or visit steel-line.com.au/wa

Sectional Garage Doors

Enhance the exterior of your home with a garage door that will complement any style of architecture. Steel-Line has a range of garage door styles to suit the unique characteristics of your home. Choose from the stylish Heritage, Stanford, Ranch, Ribline, Fineline or Flatline door styles and then select the finish of your choice to really dress up and enhance the exterior of your home.

Make a bold impression with a stunning Steel-Line sectional garage door.

Your garage door is possibly the largest exterior feature of your home so the right colour and finish treatment are essential. In addition to the Colorbond® colours, Steel-Line also offers a unique range of DecoWood® timber finishes allowing you to match your garage door to other external finishes.

Steel-Line's sectional garage doors have exceptional weather-resistant qualities. They are resilient against wind and dust conditions and come with tough PVC weather seals and heavy duty aluminium bottom rails, so you can trust that the precious contents of your garage are protected at all times.



3 easy steps to create your sectional garage door

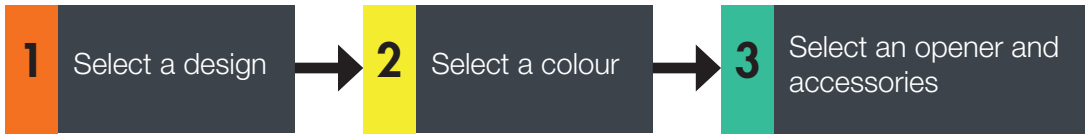

1 Door Profiles & Measurements

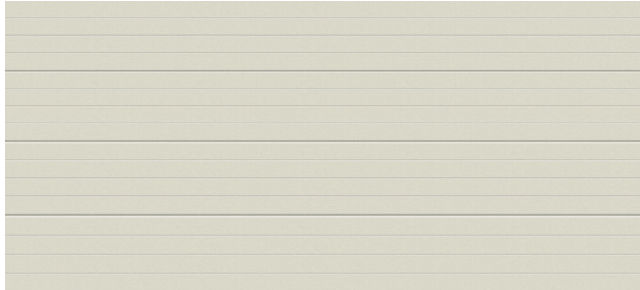

Fineline



Heritage

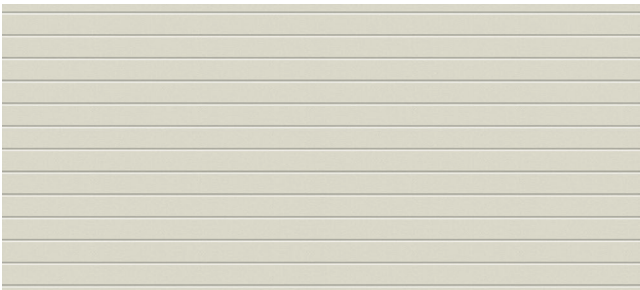

Ribline



Stanford

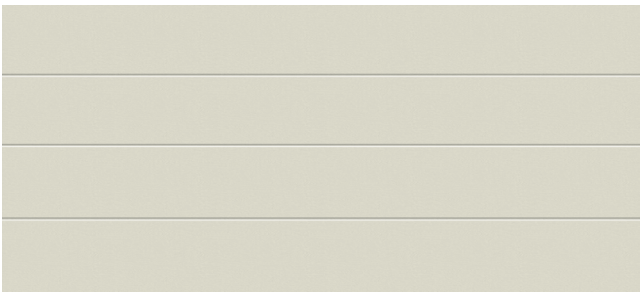

Flatline

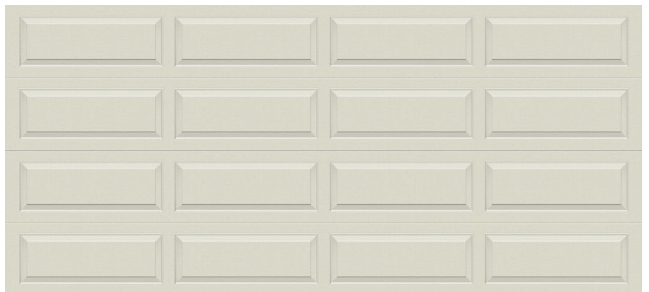

Ranch

NOTE:

- Heritage and Ranch may not be available in certain sizes
- Flatline available in smooth at additional costs

In placing an order you will be required to submit the following information.

Description	Measurements
Opening Size Height LHS	
Opening Size Height RHS	
Opening Size Width	
Side Room LHS (Min 125mm)	
Side Room RHS (Min 125mm)	
Headroom (Min 250mm)	
Backroom (Min backroom door height + 900mm)	

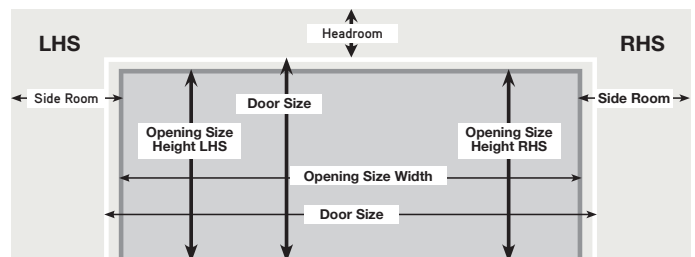

(View from inside of garage, looking out)

Example: 2160mm opening height will require a 2160mm high door.

DECO
WOOD

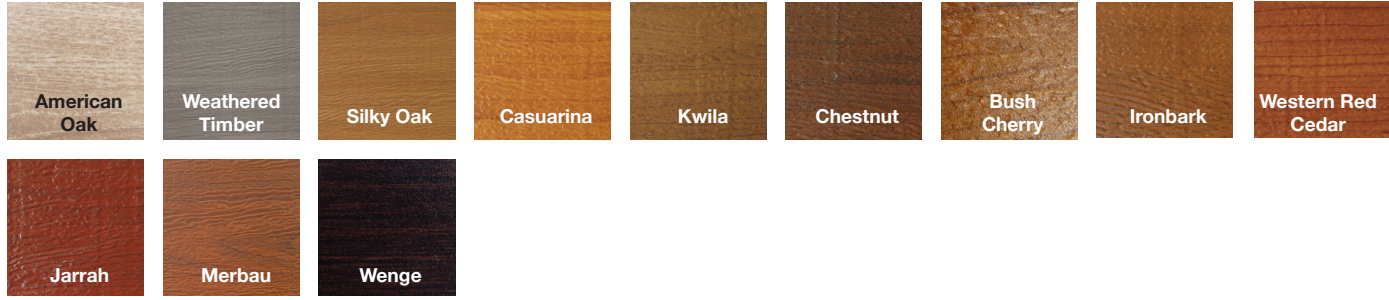

Architectural Series

UniCote
LUX

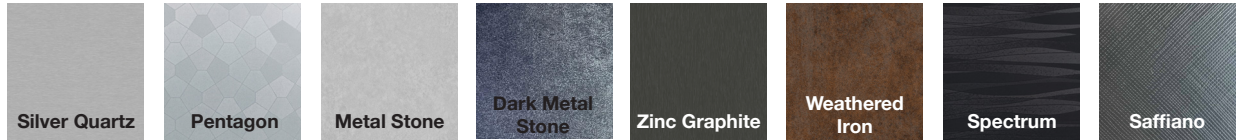

Timbers of the World Series

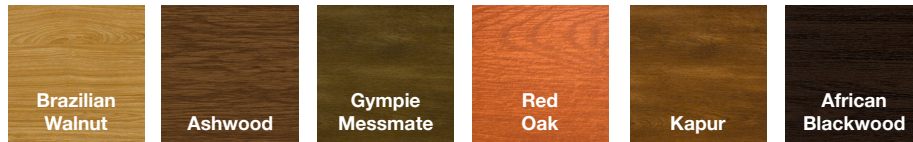

Premium
Colours



Matt Finish

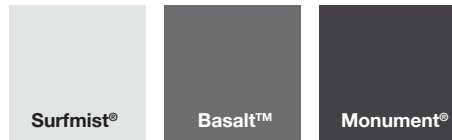

Colorbond®



NOTE:

- All colours shown on this chart are a guide only. The limitations of printing processes make extremely accurate matches impossible. We strongly recommend comparing your choice with actual samples. Additionally, Steel-Line reserves the right to vary or remove colours without notice.
- Premium colours are not available in smooth finish.
- UniCote range is only available in the Flatline, Ribline and Fineline sectional door profiles. Ashwood has a smooth finish whilst other "Timbers of the World" series have a slightly textured finish. Please see the product samples.

3 A small additional investment for greater convenience

Fit your Steel-Line sectional garage door with an automatic opener for hassle free entry to and exit from your garage.

All of our openers are engineered to the highest standards ensuring easy operation, optimum performance, long life and peace of mind.

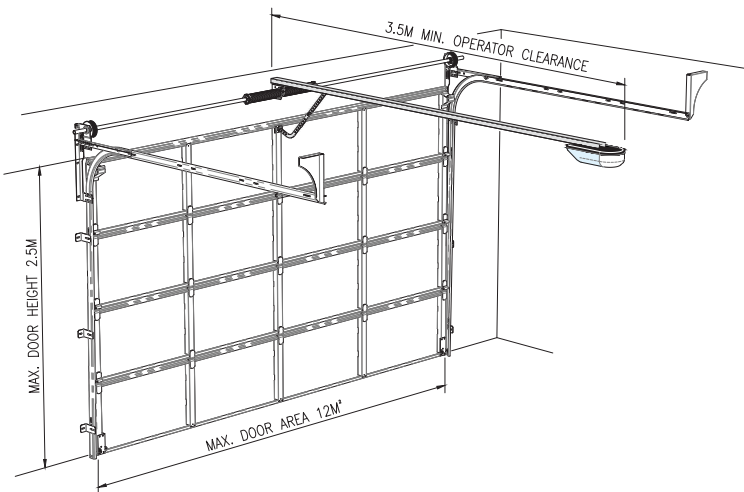

“

Some things we can't control, others you just don't have to.

”

Soft Start and Stop Function

This feature is designed to allow for a quiet and smooth garage door operation, which is important when the garage is located close to bedrooms or living areas.

Auto Reverse System

For added safety, each installation comes with this automated feature that causes the garage door to immediately stop and reverse when it comes into contact with an object.

Auto Sensing Force

During operation the force required is constantly monitored and adjusted to ensure economical operation and reduced wear and tear.

Courtesy Light

This courtesy light is the most convenient way to navigate through your garage and to get in and out of your car. The light automatically switches on and off as you open and close your garage door.

Wireless Wall Button

Can be installed near an internal access door to your garage giving you greater convenience to open and close your garage door.



Remote Handsets

The key ring remote handsets are small and convenient with the ability to operate up to four garage doors or gates from the one unit. A must have for every set of keys in the house.



Optional Wireless Keypad

Weatherproof digital keypad which can be programmed with 4 digit pin code, for maximum security. Includes back-light when used in poor lighting conditions.



Optional Emergency Key Release

Used in case of malfunction or power failure, especially useful if there is no other access to the garage.



Quality Features That Will Stand The Test Of Time

For many years Steel-Line's range of garage doors has set the benchmark for style and quality throughout the Australian garage door industry.

Most Steel-Line sectional garage doors can be automated for ease of use. As a market leader in safety and innovation, all of Steel-Line's automatic garage door openers come with a range of safety features. The standard 'Auto Reverse System' causes the garage door to immediately stop and reverse when it comes into contact with an object, while the optional 'Photo Eye' feature automatically reverses the closing garage door if its electronic beam senses an obstruction. Furthermore, to ensure smoothness of operation and one of the quietest garage door mechanisms available, Steel-Line uses specially designed composite nylon and steel hinges.

Safety Features

Steel-Line's sectional garage doors feature a curved finger proof joint for added safety. This unique award-winning design not only safeguards your family against serious injury, it seals out elements that can penetrate conventional garage doors. In addition, all internal edges of the doors are hemmed to reduce the risk of injuries near the edges.

Heavy Duty Bottom Rail

Every Steel-Line sectional garage door is fitted with a sturdy heavy duty bottom rail to increase strength in the lower part of the garage door. A tough and durable weather seal is added to the bottom rail for extra protection from the elements.

Truefit Pelmet

The Truefit pelmet system creates a clean, modern and seamless finish by integrating the pelmet into the front of the garage door so it is in line, replacing the boxed pelmet extruding from the top of the door. The aesthetic achieved enhances the elevation of your door and can save hundreds of dollars on building costs, as the steel lintel and brickwork across the door opening is no longer required.

Strong Hinges

Steel-Line uses heavy duty steel hinges for trouble free operation.



FingerProof™ Safety Feature



Heavy Duty Bottom Rail



Truefit Pelmet



Strong Hinges

Proudly distributed by:



Call 1300 427 243 | steel-line.com.au/wa