

## Floor Plan Views

X = Structural support minimum "A" series 75mm, "AA" series 100mm, "B" series 100mm

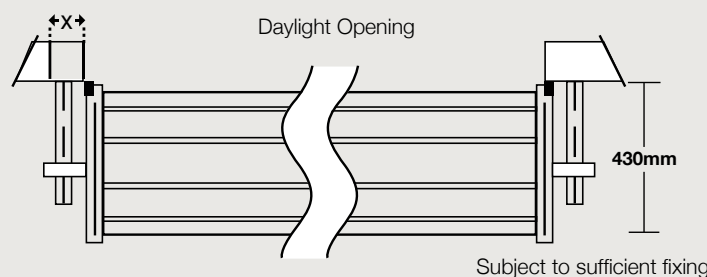

Plan View

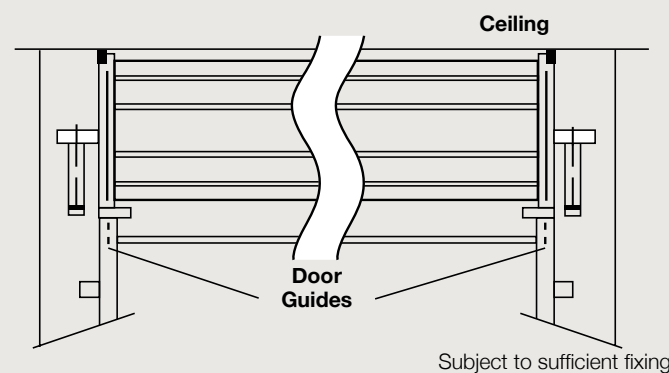

View from Inside Looking Out

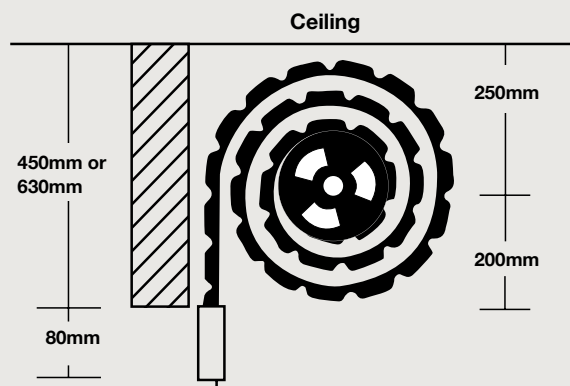

End View

## Designed to be tough and durable

Steel-Line's range of roller doors is the benchmark for style and quality in Australian garage doors. The following technical features ensure that your Steel-Line garage door will operate efficiently for years to come.

## Australian Made Steel

Steel-Line roller doors are made from genuine BlueScope Colorbond® and Zinalume\*; top quality steel that stands the test of time.

## Quality Drums and Springs

All Steel-Line garage doors revolve on precision-made drum wheels. Garage doors are counter-balanced using helical coil springs to ensure perfect balance and operation. All our springs are heat treated and tempered to give years of trouble free operation.

\* BlueScope® Steel is our preferred supplier. However, we may use equivalent steel from an alternative supplier.

## Superior, Unique Profile

The exclusive Steel-Line garage door curtain has a unique roll formed profile that is engineer-designed for superior strength, whilst maintaining a unique modern appearance sure to enhance the exterior of your home.

### Optional Extras:

- Ventilated Profile - gives an effective airflow up to 9% for standard roller doors
- Tapered Bottom Panel - for garage floors that slope across the opening

## Centre Lock

All Steel-Line residential garage roller doors have a factory fitted centre lift locks generally mounted waist high and operated by key externally. It also features an internal keyless manual override that offers security and a safe exit in an emergency.

### Optional Extra:

- Windlock Clip - provides extra security in high wind areas

If you require a roller door for cyclonic regions, please refer to our Wind Rated Roller Door brochure, or contact your local Steel-Line branch for more details.

## Dual-Sided Nylon Webbing

We apply nylon-fibre webbing to both sides of the garage door curtain eliminating metal-on-metal contact resulting in an extremely quiet and smooth operating door for years to come.

## Aluminium Bottom Rail

An engineer-designed, heavy-duty extruded aluminium bottom rail is used to strengthen the bottom panel of the garage door. The bottom rail also incorporates a specially designed weather seal, extruded from tough and durable PVC to protect your garage from the harsh elements.

Proudly distributed by:

ZBROCLR-V12 (0618) Copyright © Steel-Line Garage Door Australia. All rights reserved.



Roll Formed Profile



Centre Lock



Dual-sided Nylon Webbing

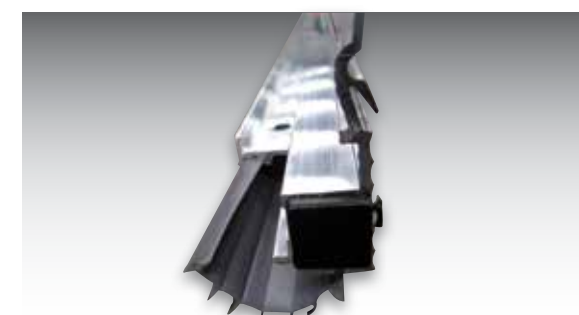

Aluminium Bottom Rail (Weather Seal)



Call 1300 427 243 | [steel-line.com.au](http://steel-line.com.au)

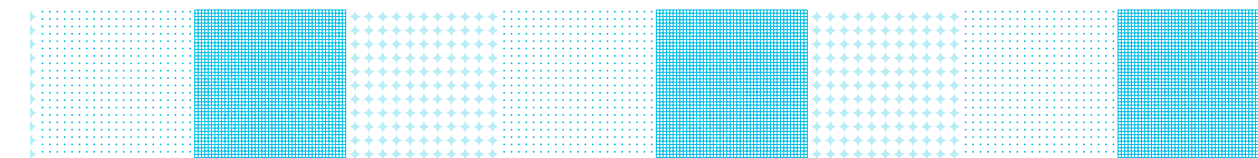

makers  
for life



# Roller Doors

If you're ready to draw the line at average and reach for better call us today.

To locate Steel-Line branches across Australia call: **1300 427 243** or visit [steel-line.com.au](http://steel-line.com.au)



Easy to use and long lasting, Steel-Line's garage roller doors can be made to suit almost any size opening. Combine this with a range of Colorbond® colours and smooth operation, Steel-Line garage roller doors become true design features of your home.

**Our garage roller doors combine a unique profile with first class materials making them the strongest, quietest and most reliable doors available.**

Manufactured with heavy duty bottom rails containing durable PVC weather seals, Steel-Line's garage roller doors provide your precious garage contents with excellent protection from the harsh elements including wind, rain and dust.

All Steel-Line roller doors can be automated with a quality approved automatic opener. As a market leader in safety and innovation, all Steel-Line approved openers include a range of safety and convenient features. The standard 'Auto Reverse System' causes the garage door to immediately stop and reverse when it comes into contact with an object, while the optional extra, 'Photo Eye' feature automatically reverses the closing garage door if its electronic beam senses an obstruction.

## 3 easy steps to order your roller door

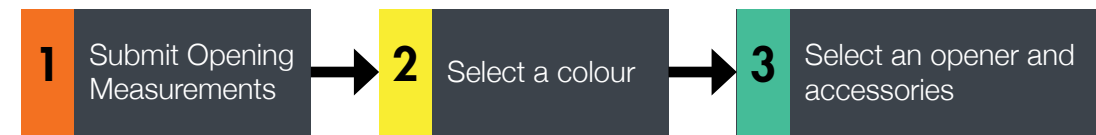

### 1 Submit Opening Measurements

In placing an order you will be required to submit the following information.

The range of available sizes in "A" series, "AA" series and "B" series:

#### "A" series residential door

(Range from 900mm to 3430mm in width)

"A" Series Door Heights
Up to and including 1200mm
Up to and including 2100mm
Up to and including 2200mm
Up to and including 2400mm
Up to and including 2600mm
Up to and including 2700mm
Up to and including 3000mm

#### "AA" series residential door

(Range from 3435mm to 5500mm in width)

"AA" Series Door Heights
Up to and including 2200mm
Up to and including 2400mm
Up to and including 2600mm
Up to and including 2700mm
Up to and including 3000mm

#### "B" series light industrial door

(Range from 3101mm to 5100mm in width)

"B" Series Door Heights
Up to and including 3300mm
Up to and including 3600mm
Up to and including 4200mm
Up to and including 4800mm
Up to and including 5100mm

Description	Measurements
Opening Size Height LHS	
Opening Size Height RHS	
Opening Size Width	
Side Room LHS	
Side Room RHS	
Headroom	

<b>Door Size - Width</b>	"A" series = Opening Size + 50mm "AA" series = Opening Size + 100mm "B" series = Opening size + 100mm
<b>Door Size - Height</b>	Refer to "A" series and "AA" series and "B" series above
<b>Side Room - Manual</b>	"A" series = 90mm minimum "AA" series = 125mm minimum "B" series = 185mm minimum
<b>Side Room - With Automatic Opener</b>	"A" series = 120mm minimum "AA" series = 150mm minimum "B" series = 150mm minimum*
<b>Headroom - Minimum</b>	"A" and "AA" series = 430mm-510mm* "B" series = up to 570mm*
<b>Restricted - Headroom</b>	= door opening height may be restricted

**NOTE:** The above table is a guide only and some dimensions may change.

\* Please refer to Steel-Line Roller Door Technical Data Sheet for more details.

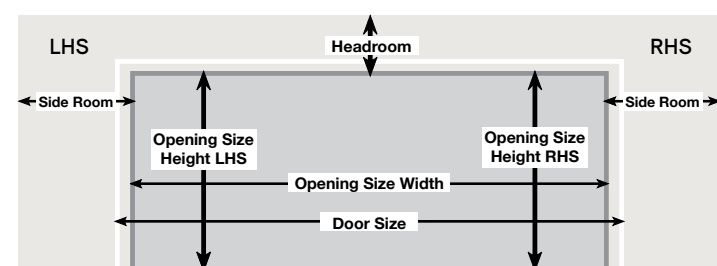

(View from inside of garage, looking out)

## 2 Colour Options



**NOTE:** The colours shown are a guide only. The limitations of printing processes make extremely accurate matches impossible. We strongly recommend comparing your choice with actual samples. Additionally, Steel-Line reserves the right to vary or delete colours without notice.

## 3 A small additional investment for greater convenience

### Roller Door Openers

Fit your Steel-Line garage roller door with an automatic opener for hassle free entry to and exit from your garage or shed.

All of our openers are engineered to the highest standards ensuring easy operation, optimum performance, long life and peace of mind.

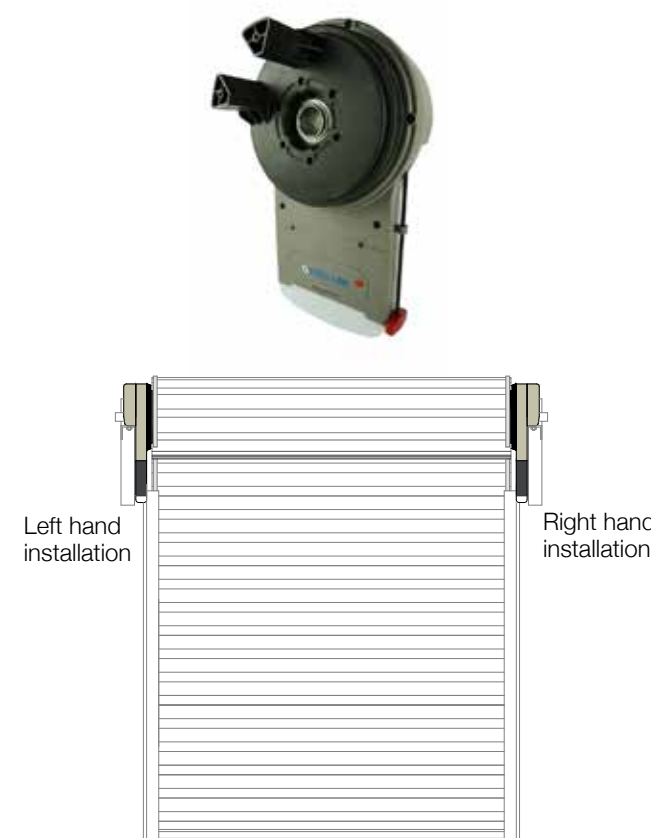

### Soft Start and Stop Function

This feature is designed to allow for a quiet and smooth door operation, which is important when the garage is located close to bedrooms or living areas.

### Door Stop Programming

This convenient feature allows for the door to be stopped at any height for the purpose of ventilation or pet access.

### Auto Reverse System

For added safety, each installation comes with this automated feature that causes the garage door to immediately stop and reverse when it comes into contact with an object.

### Courtesy Light

This courtesy light is the most convenient way to navigate through your garage and to get in and out of your car. The light automatically switches on as you open the door and switches off automatically after about 2 minutes.

### Wireless Wall Button

Can be installed near an internal access door to your garage giving you greater convenience to open and close your garage door.



### In-built Safety Timer

This automatic close timer will ensure that your door will close automatically (with optional photo eye beams installed) if you forget to close it yourself. This is a fantastic security feature that will ensure that you have peace of mind.

### Remote Handsets

The key ring remote handsets are small and convenient with the ability to operate up to three garage doors or gates from the one unit. A must have for every set of keys in the house.



### Quality and Adaptability

Our roller door openers are manufactured from quality composite materials, and are approved to the latest world-wide standards. They can also be fitted to most popular brands of roller doors with accessories to suit your requirements.

## Automatic Opener Accessories

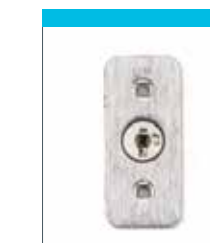

**Emergency Key Release**

Used in case of malfunction or power failure, especially useful if there is no other access to the garage.

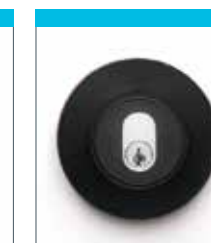

**Electronic Key Switch**

Allows entry into your garage from outside, via a key lock. Useful when remote handset is not available.



**'Photo Eye' Technology**

For added safety, this allows the garage door to automatically reverse when its sensor light beam is broken by an obstruction, helping to protect your family from injury and your car from the damage caused by contact.



**Wireless Keypad**

Weatherproof digital keypad with cover which can be programmed with 4 digit pin code, for maximum security. Includes back-light when used in poor lighting situations.



**Remote Handsets**

A must for every set of keys in the household. The handset memory register will hold up to 20 handset codes.



**Wireless Wall Mounted Remote**

Can be installed near an internal access door to your garage giving you greater convenience to open and close your garage door.